



FEATURES

- Field-Bus remote data acquisition
- Modbus Slave device on RS-485
- Modbus RTU/ Modbus ASCII protocol
- 4 channels input up to $\pm 20\text{ mA}$
- Watch-Dog Alarm
- Remotely Configurable
- 2000 Vac 3-ways Galvanic Isolation
- High Accuracy
- UL / CE mark
- DIN rail mounting in compliance with EN-50022



GENERAL DESCRIPTION

The device DAT 3015-I is able to acquire up to 4 analogue input signals. The data are transmitted with MODBUS RTU/MODBUS ASCII protocol on the RS-485 network (RS-232 interface is available).

It is possible to connect on input current signals up to $\pm 20\text{ mA}$.

The device guarantees high accuracy and stable measure versus time and temperature.

To ensure the plant safety, two Watch-Dog timer alarms are provided.

The isolation between the parts of circuit removes eventual ground-loop effects, allowing the use of the device even in the heavy environmental conditions.

The DAT 3015-I is in compliance with the Directive UL 61010-1 for US market and with the Directive CSA C22.2 No 61010-1 for the Canadian market.

The device is housed in a rough self-extinguishing plastic container which, thanks to its thin profile of 17.5mm only, allows a high density mounting on EN-50022 standard DIN rail.

COMMUNICATION PROTOCOLS

The DAT 3015-I is designed to work with the MODBUS RTU/MODBUS ASCII protocol: standard protocol in field-bus; allows to directly interface DAT3000 series devices to the larger part of PLCs and SCADA applications available on the market.

For the protocol instructions, refer to the User Guide of the device.

USER INSTRUCTIONS

Before to install the device, please read the "Installation Instruction" section.

If the module configuration is unknown, with device powered off, connect the INIT terminal to the GND terminal (ground), at the next power on the device will be auto-configured in the default settings (refer to the User Guide of the device).

Connect power supply, serial bus and analogue inputs as shown in the "Wiring" section.

The "PWR" LED state depends on the working condition of the device: see the "Light Signalling" section to verify the device working state.

To perform configuration and calibration operations, read the instructions in the User Guide of the device.

To simplify handling or replacing of the device, it is possible to remove the wired terminals even with the device powered.

TECHNICAL SPECIFICATIONS (Typical @ 25 °C and in the nominal conditions)

INPUT			Input Accuracy (1) Current	$\pm 20\text{ uA}$	POWER SUPPLY	
Input type	Min	Max				
Current			Linearity (1) Current	$\pm 0.1\% \text{ f.s.}$	Power supply voltage	
20 mA	-20 mA	+20mA			Current	30 mA max.
			Input Impedance Current	$\leq 22\ \Omega$	Reverse polarity protection	
					Thermal drift (1) Full scale	$\pm 0.005\% / ^\circ\text{C}$
			Sample time	0.5 + 1 sec.	ISOLATION	
					Data Transmission	Baud Rate
			Max. distance	1.2 Km – 4000 ft	Input – RS485	
					ENVIRONMENTAL CONDITIONS	Operative Temperature
					UL Operative Temperature	-10°C .. +40°C
					Storage Temperature	-40°C.. +85°C
					Humidity (not condensed)	0 .. 90 %
					Maximum Altitude	2000 m
					Installation	Indoor
					Category of installation	II
					Pollution Degree	2
					MECHANICAL SPECIFICATIONS	
					Material	Self-extinguish plastic
					IP Code	IP20
					Wiring	wires with diameter 0.8+2.1 mm ² /AWG 14-18
					Tightening Torque	0.5 N m
					Mounting	in compliance with DIN rail standard EN-50022
					Weight	about 150 g.
					CERTIFICATIONS	
					EMC (for industrial environments)	
					Immunity	EN 61000-6-2
					Emission	EN 61000-6-4
					UL	
					US Standard	UL 61010-1
					Canadian Standard	CSA C22.2 No 61010-1
					CCN	NRAQ/NRAQ7
					Typology	Open Type device
					Classification	Industrial Control Equipment
					File Number	E352854

(1) Referred to input Span (difference between max. and min. values)

INSTALLATION INSTRUCTIONS

The DAT 3015-I is suitable for fitting to DIN rails in the vertical position. For optimum operation and long life follow these instructions:

When the devices are installed side by side it may be necessary to separate them by at least 5 mm in the following case:

- If panel temperature exceeds 45°C and at least one of the overload conditions exist.

Make sure that sufficient air flow is provided for the device avoiding to place raceways or other objects which could obstruct the ventilation slits. Moreover it is suggested to avoid that devices are mounted above appliances generating heat; their ideal place should be in the lower part of the panel. Install the device in a place without vibrations.

Moreover it is suggested to avoid routing conductors near power signal cables (motors, induction ovens, inverters etc...) and to use shielded cable for connecting signals.

CABLING

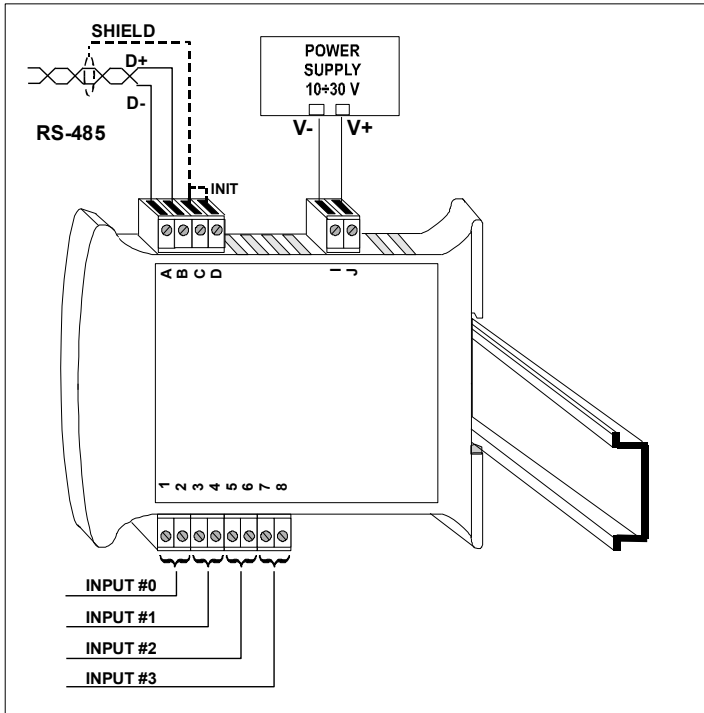

LIGHT SIGNALLING

LED	COLOUR	STATE	DESCRIPTION
PWR	GREEN	ON	Device powered
		OFF	Device not powered / Wrong RS-485 cabling.
		FAST BLINK	Communication in progress (blink frequency depends to baud-rate)
		1 second BLINK	Watch-Dog Alarm condition

MECHANICAL DIMENSIONS (mm)

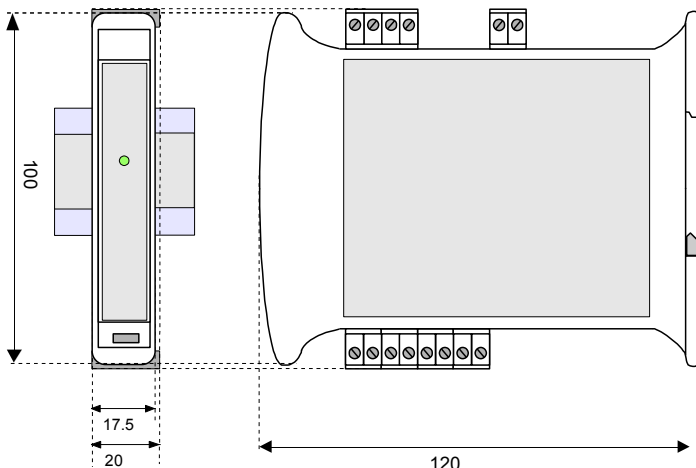

WIRING

ANALOG INPUT

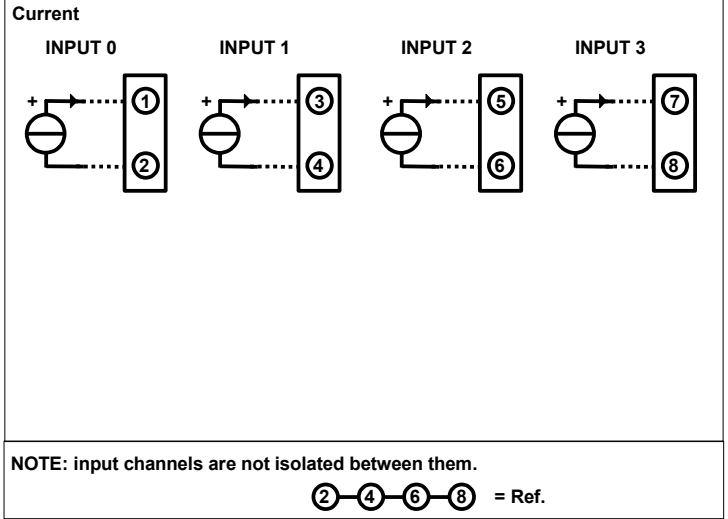

RS-485 NETWORK

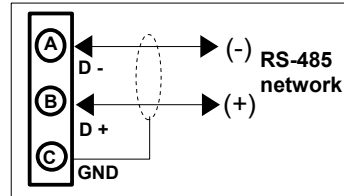

RS-232 NETWORK

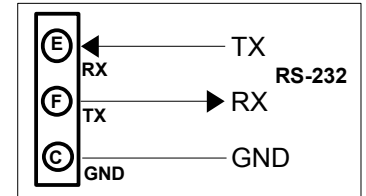

POWER SUPPLY (*)

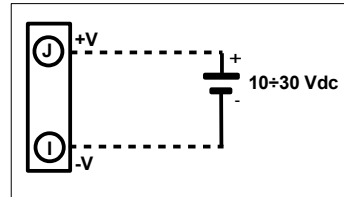

INIT

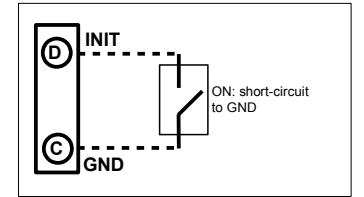

(*) Note: for UL installation the device must be powered using a power supply unit classified NEC class 2 or SELV

ISOLATION STRUCTURE

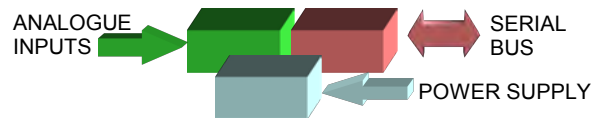

HOW TO ORDER

In the order phase, it is mandatory to specify the interface type (RS485 or RS232).

ORDER CODE:

DAT 3015-I / 485

Interface type
485 : RS-485
232 : RS-232

■ = Requested
□ = Optional



The symbol reported on the product indicates that the product itself must not be considered as a domestic waste. It must be brought to the authorized recycle plant for the recycling of electrical and electronic waste. For more information contact the proper office in the user's city, the service for the waste treatment or the supplier from which the product has been purchased.